

Журнал для дошкольников

В этом номере:

Задания для подготовки руки к письму

Выполни штриховку

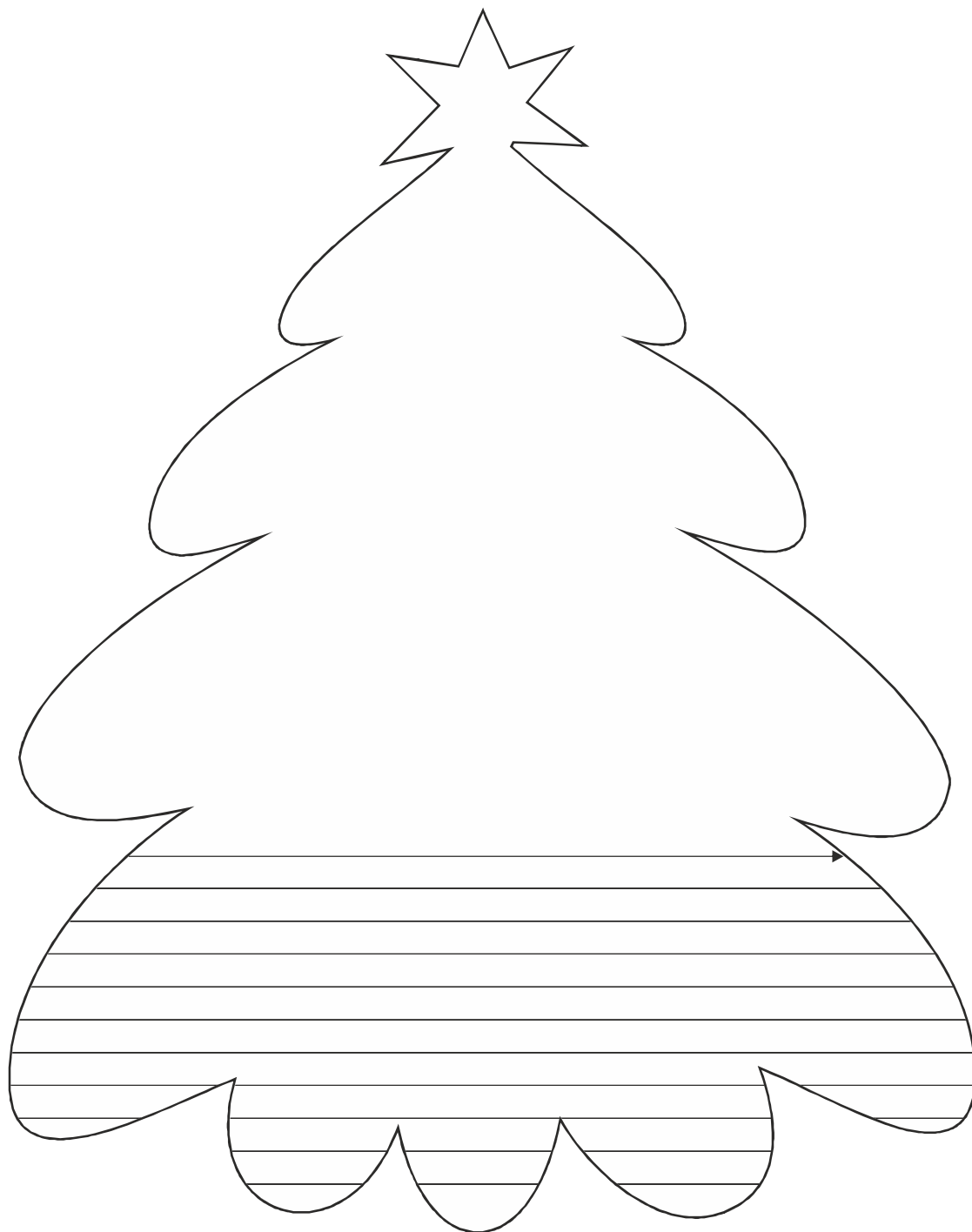

Выполни штриховку

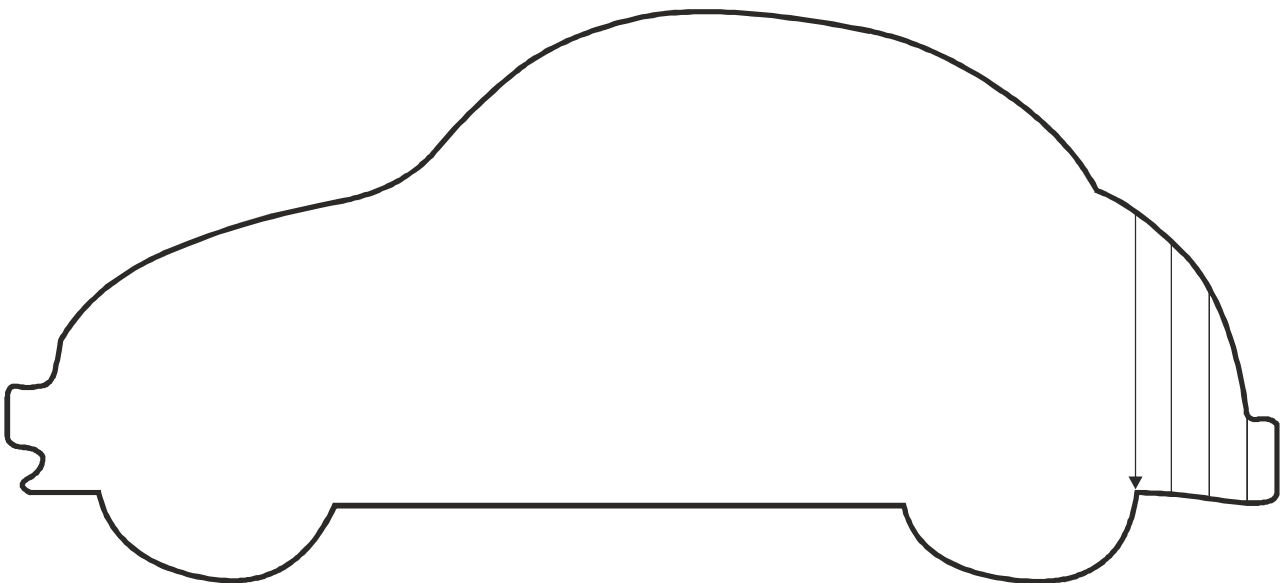
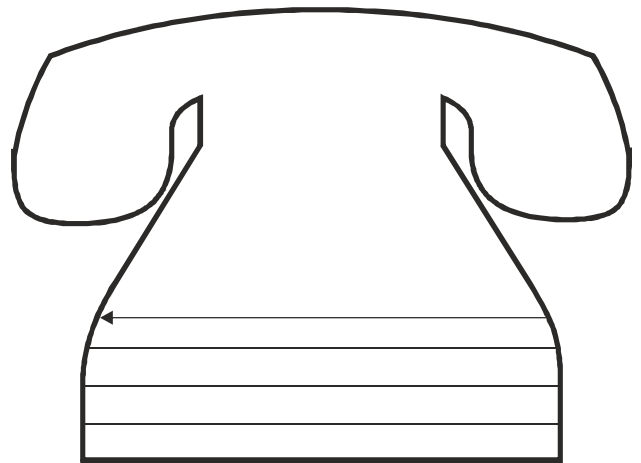
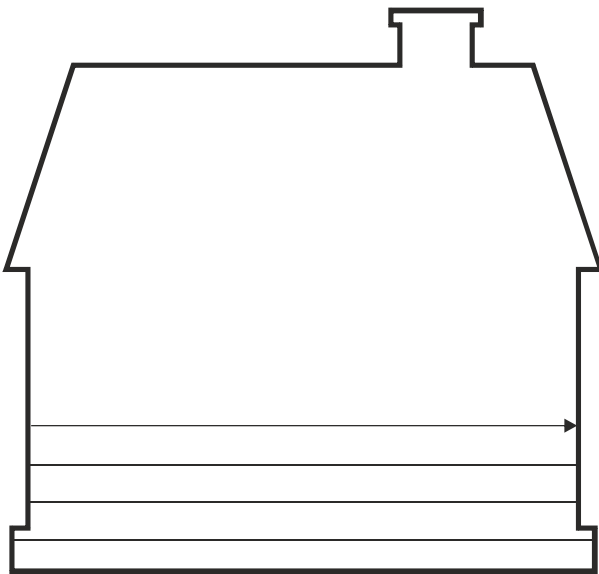
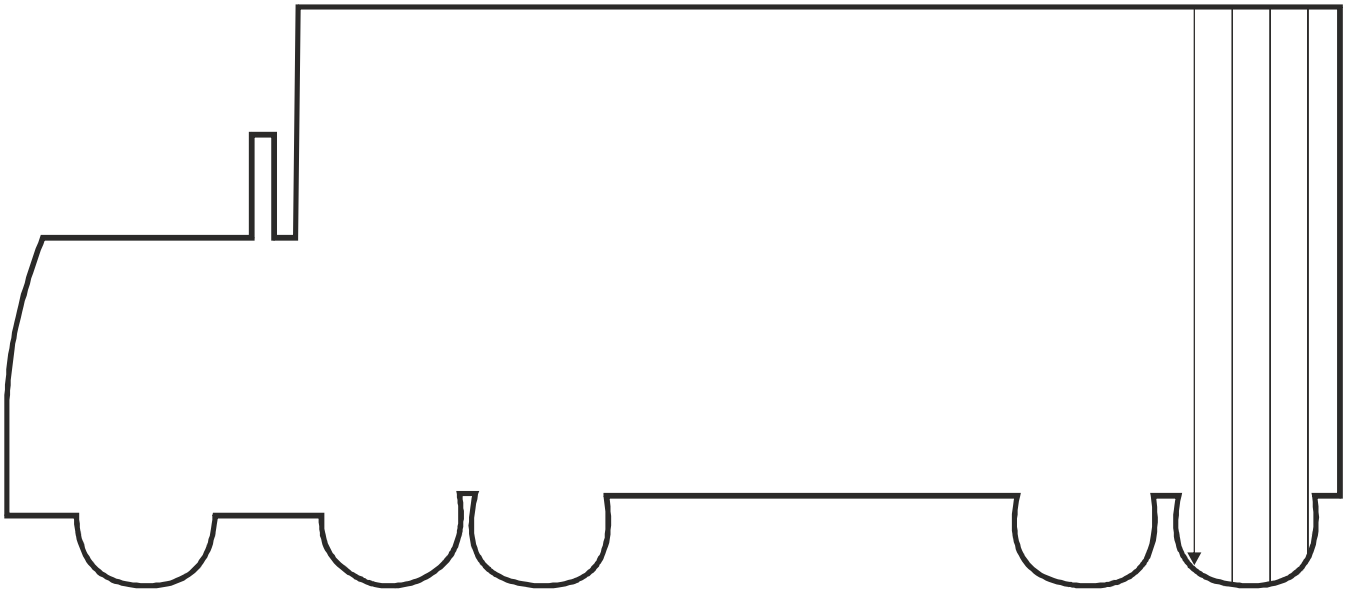

Выполни штриховку

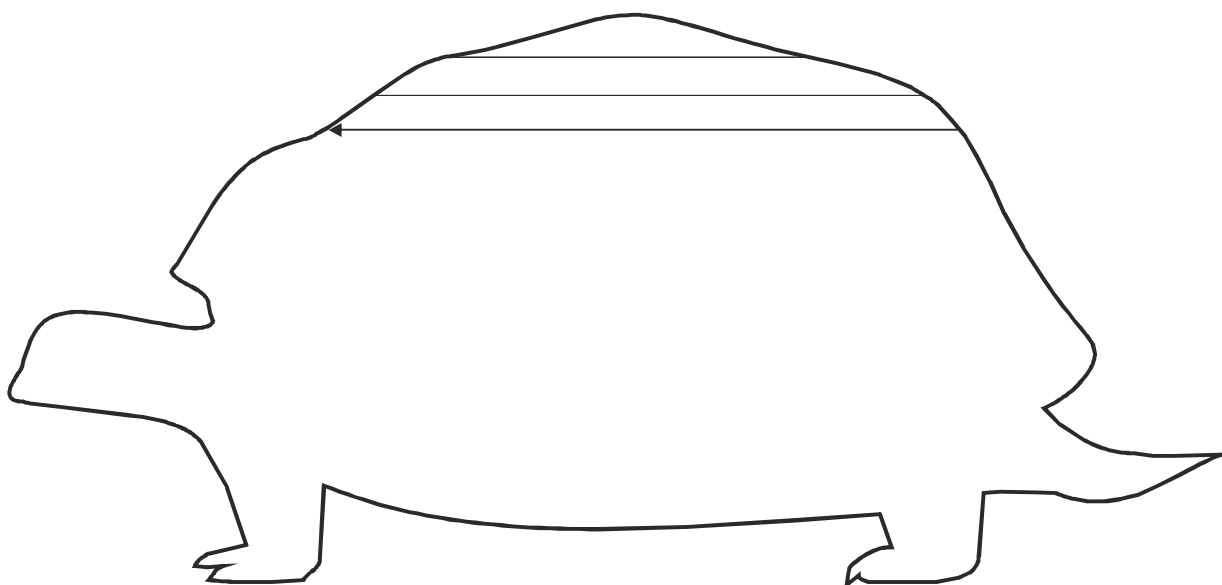
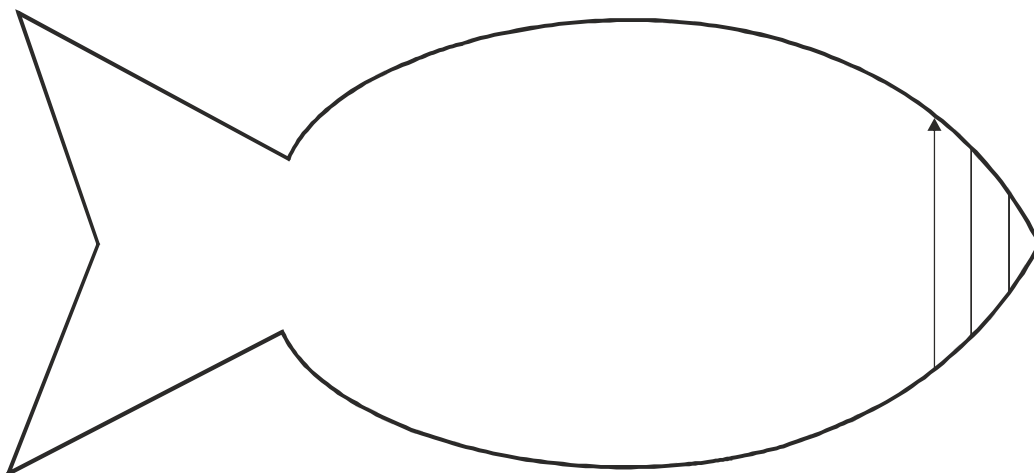
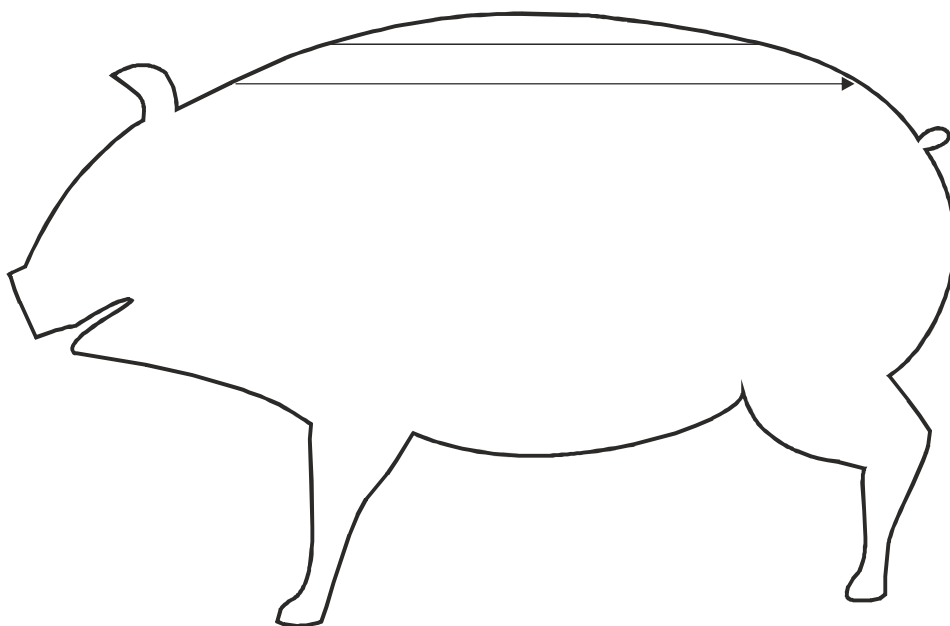

Выполни штриховку

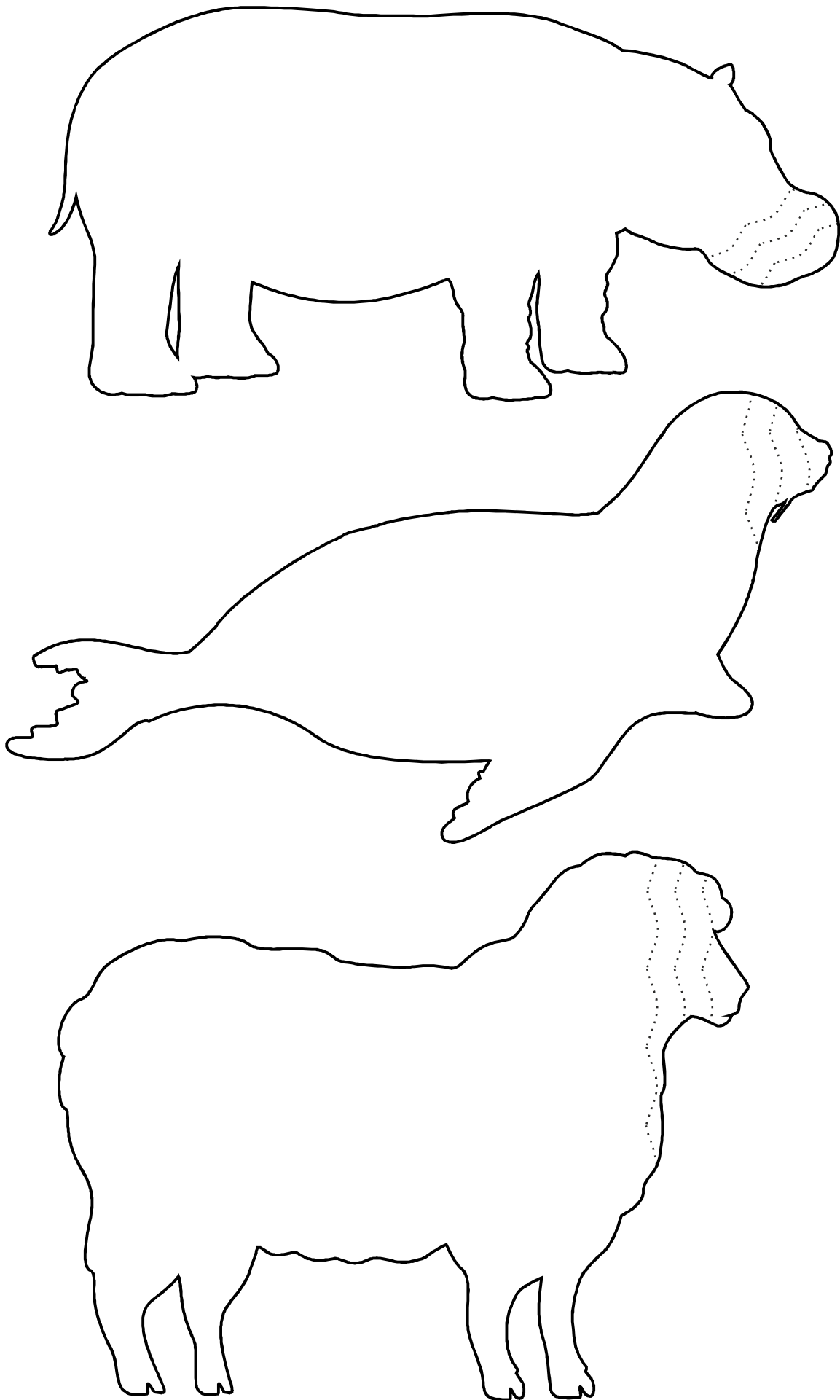

Обведи картинки по контуру

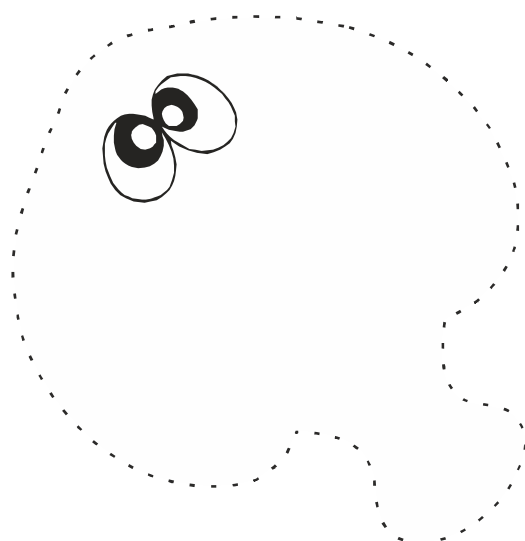
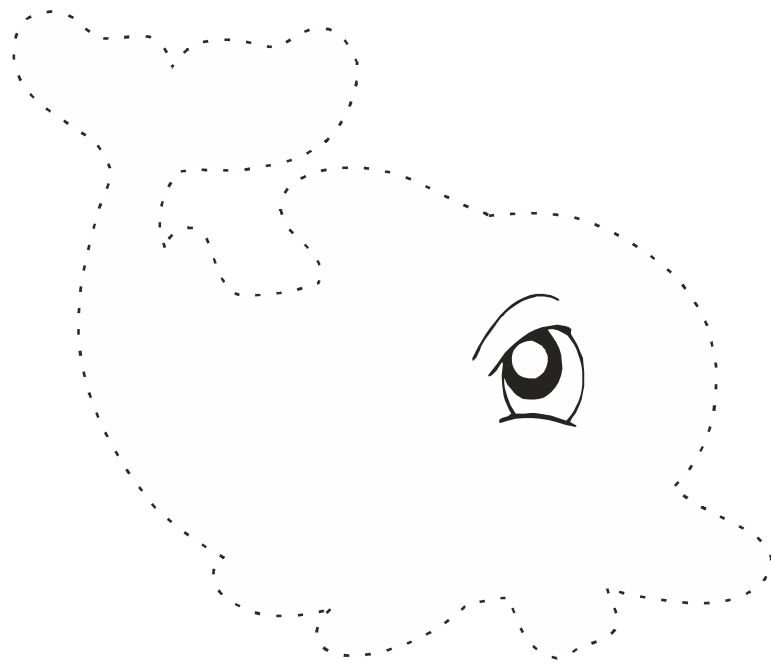
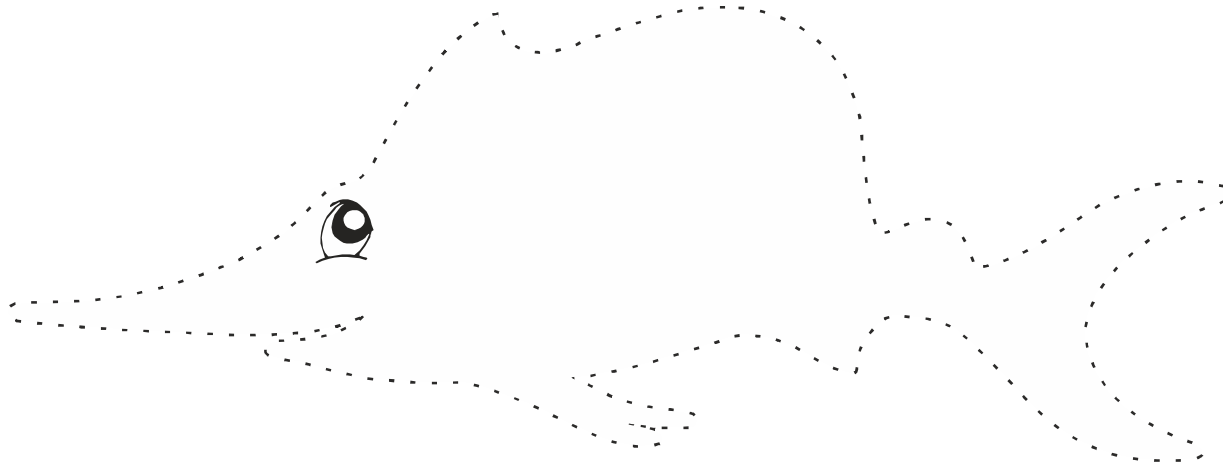
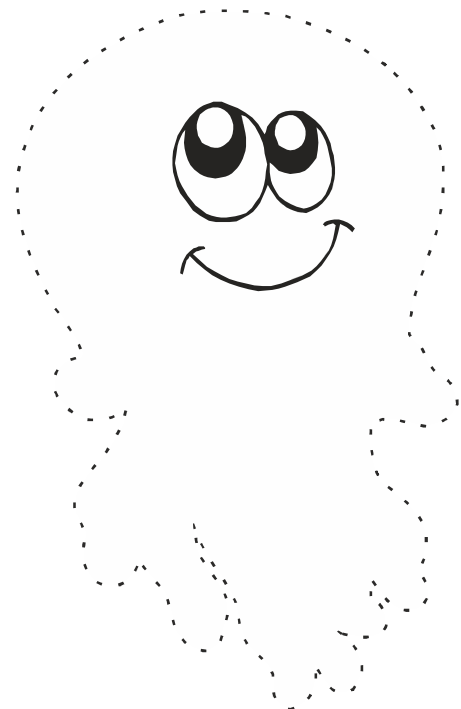
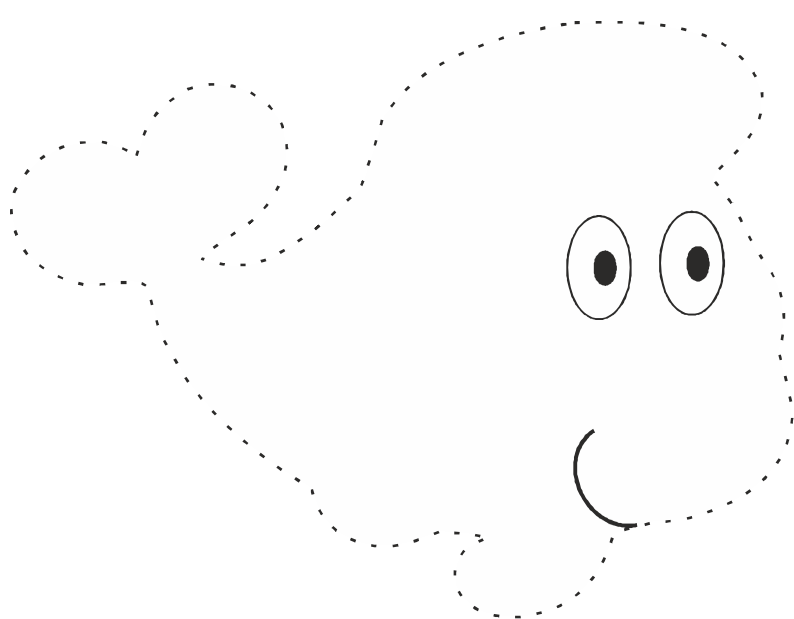

Обведи картинки по контуру

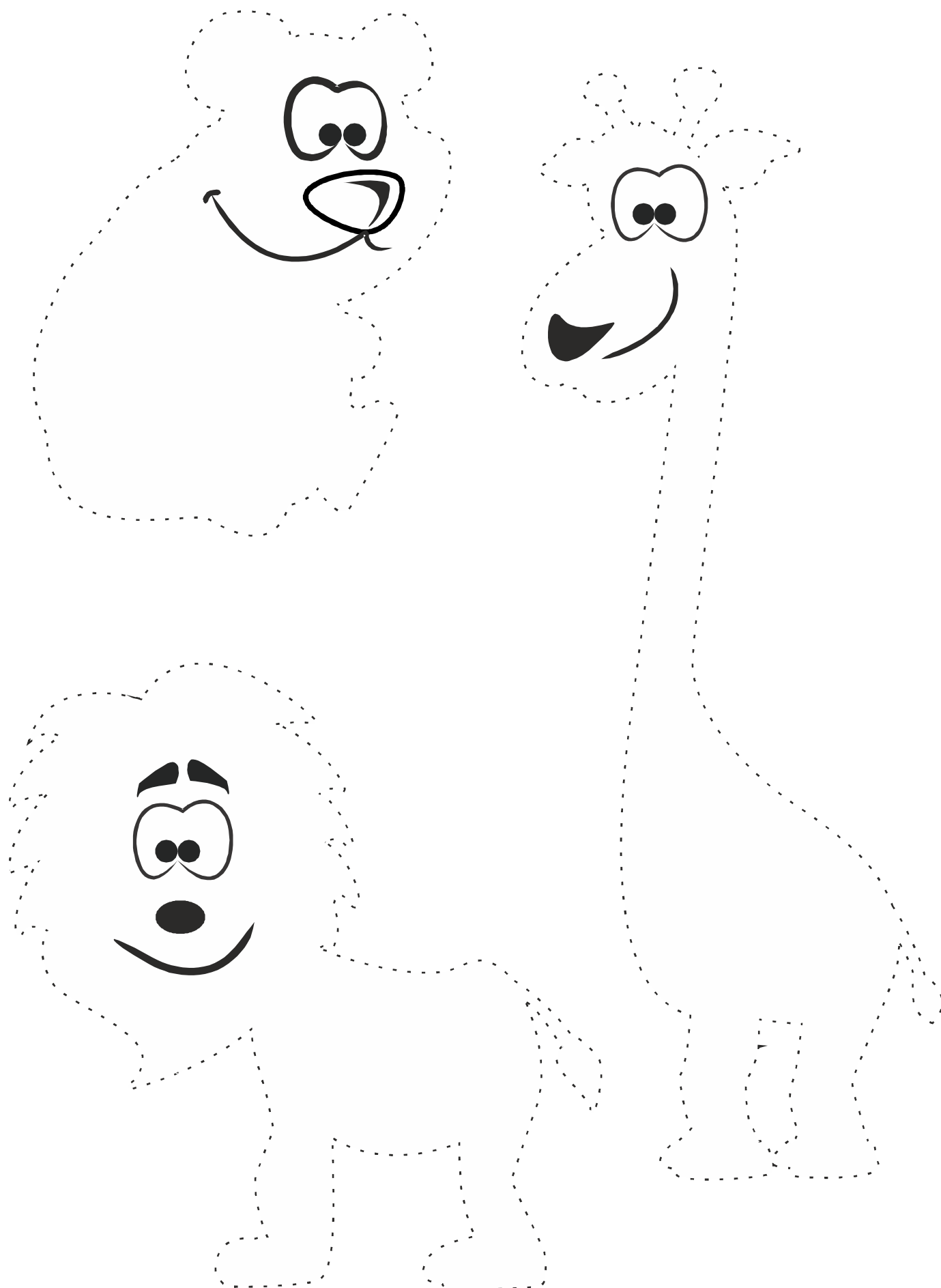

Обведи картинки по контуру

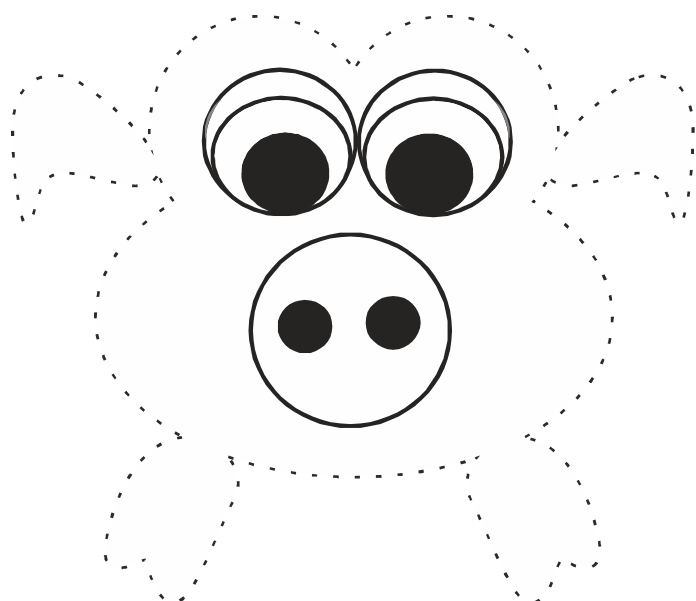
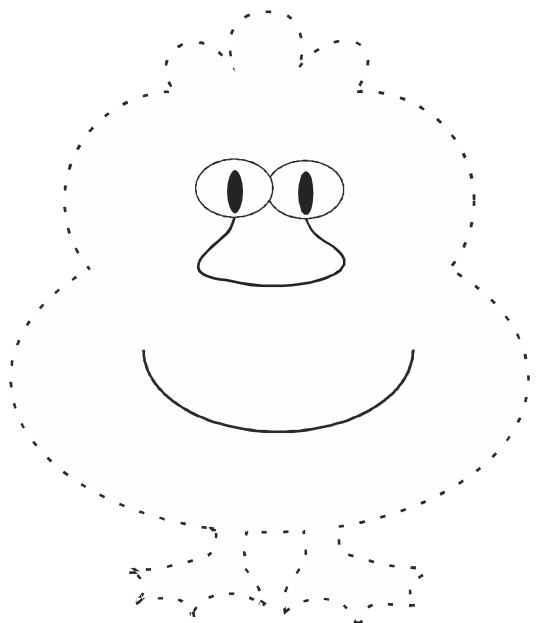
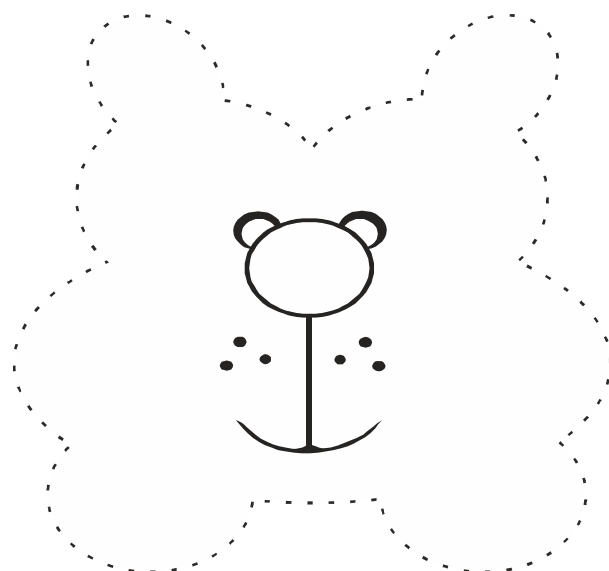
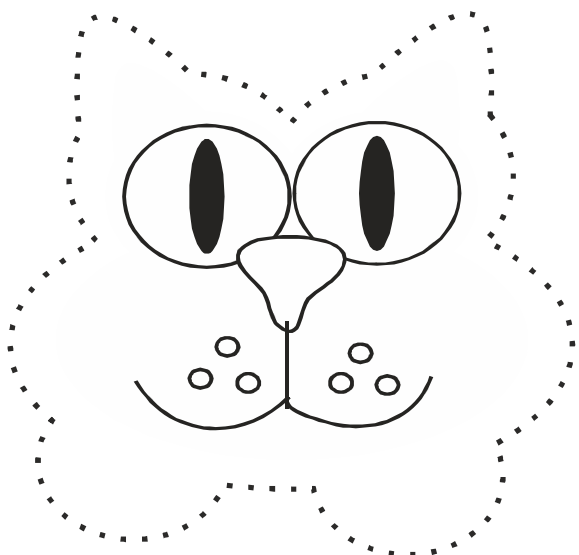
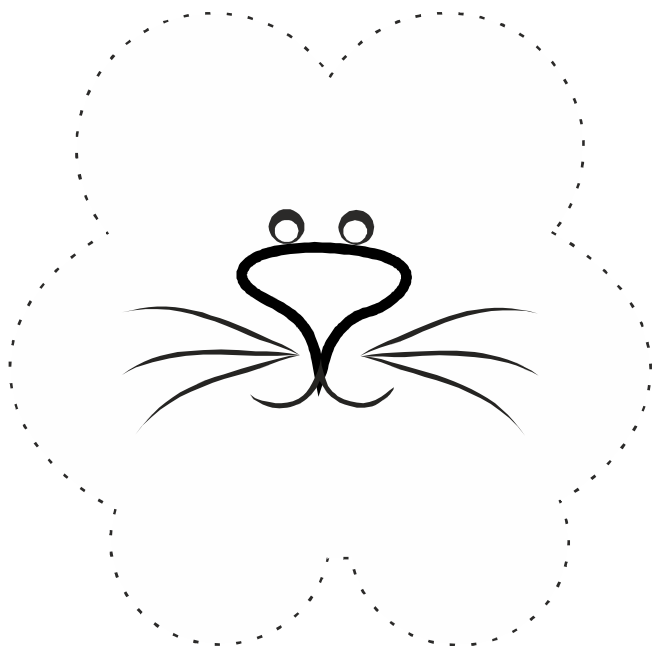
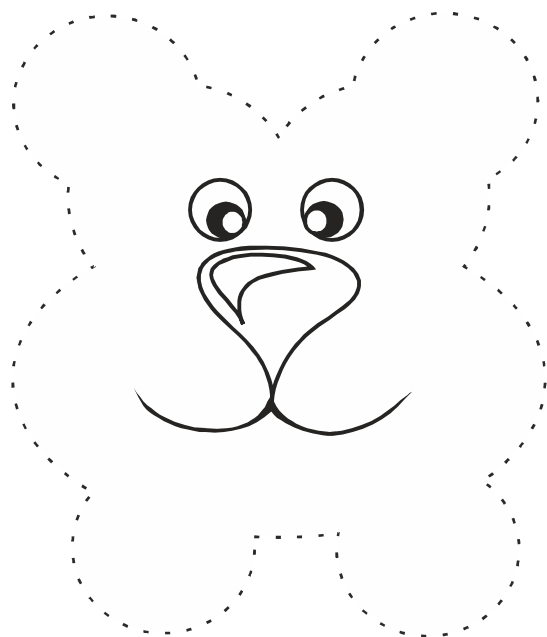

Обведи картинки по контуру

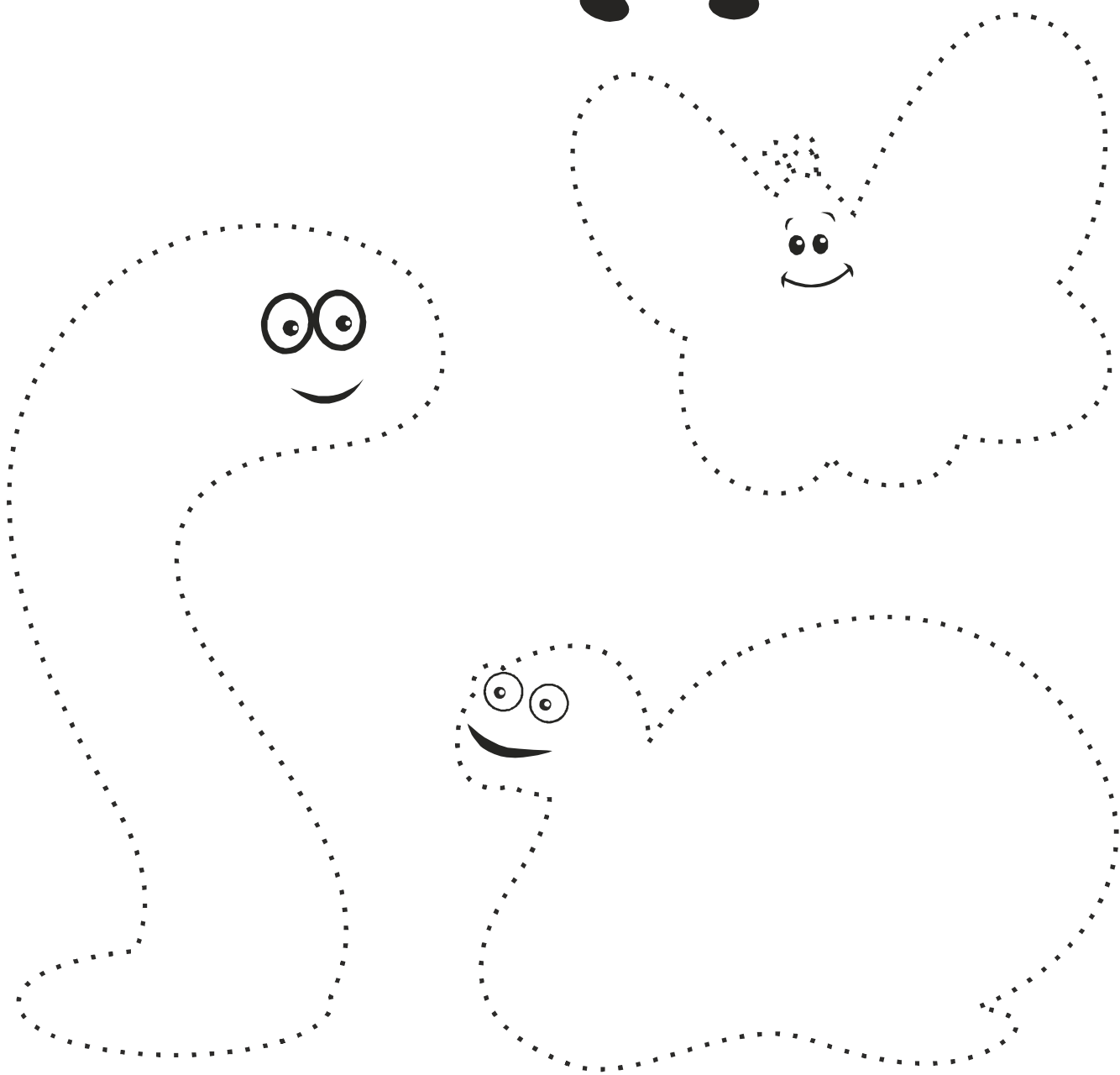
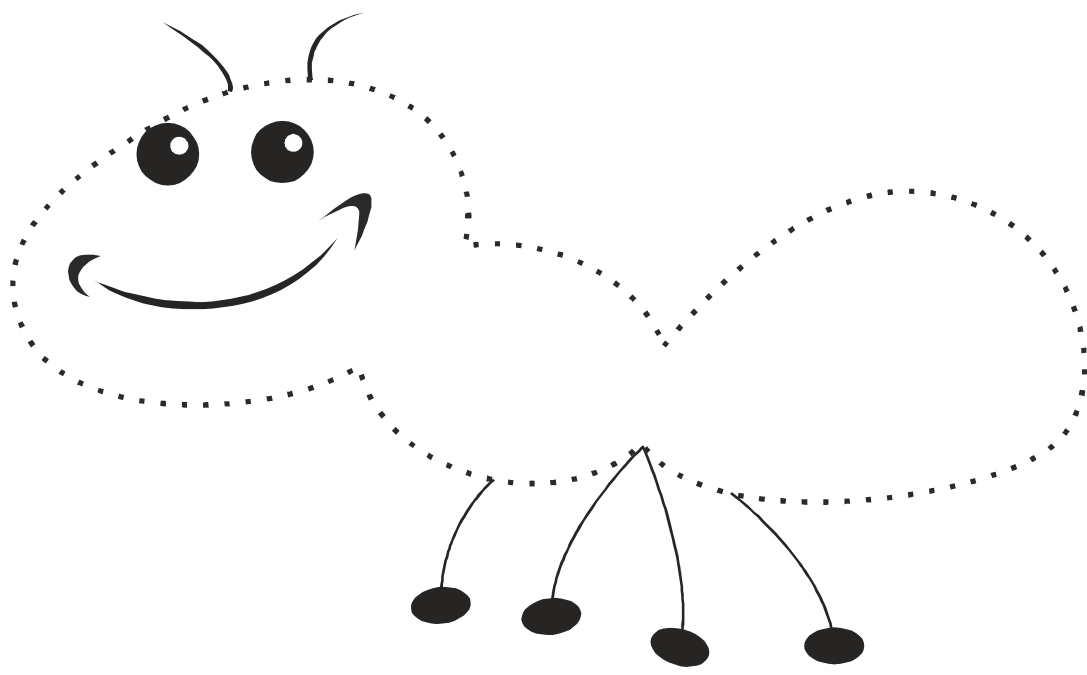

Нарисуй в пустых ячейках такие же фигуры

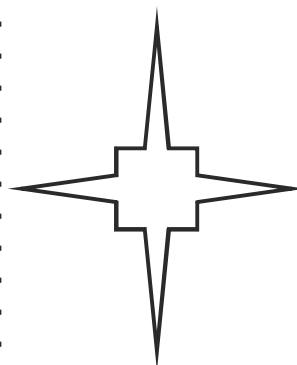
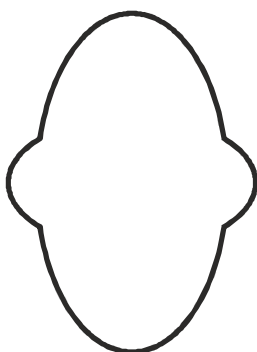
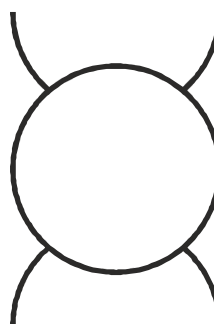
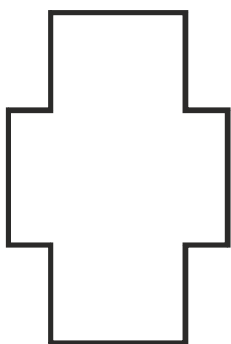
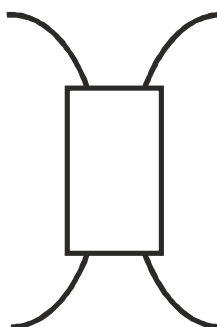
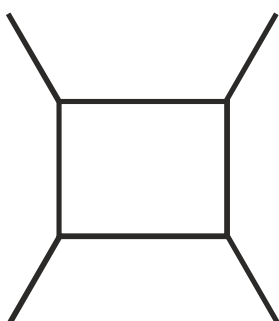
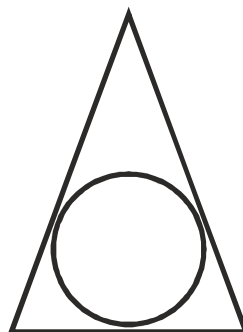
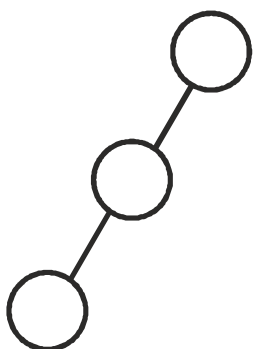

Нарисуй в пустых ячейках такие же фигуры

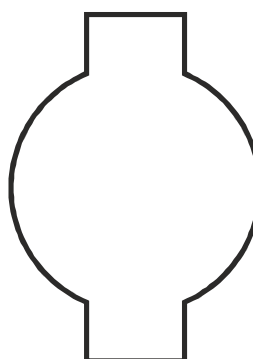
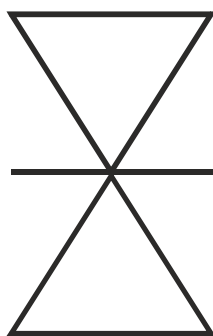
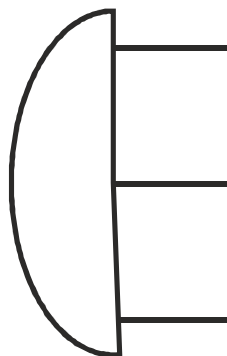
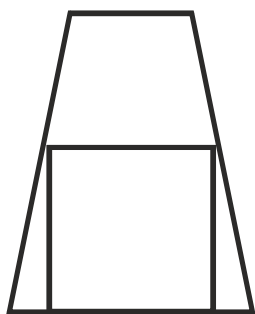
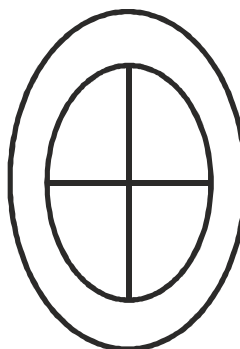
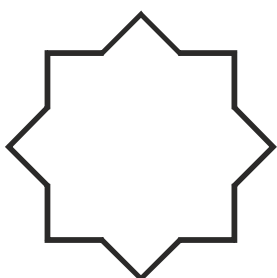
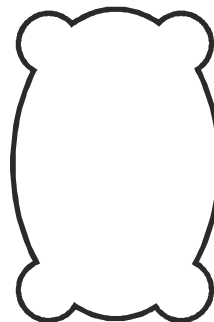
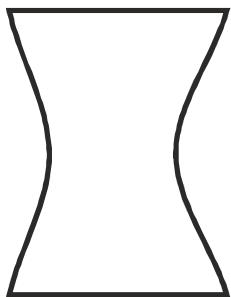

Дорисуй вторую и третью фигуры точно так же, как первую

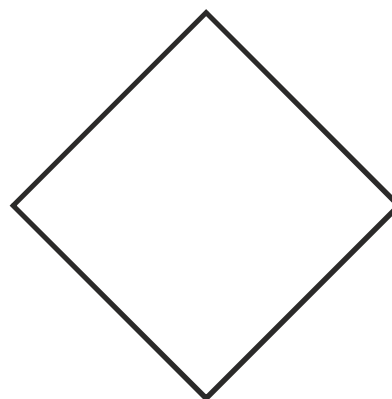
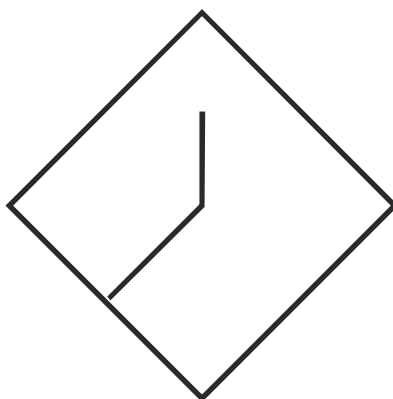
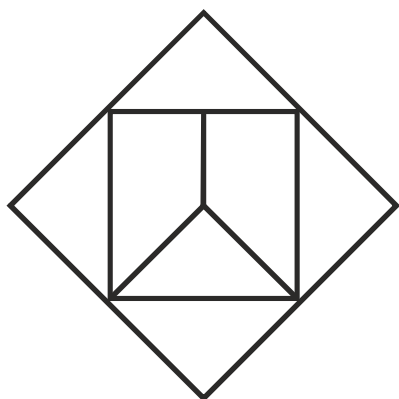
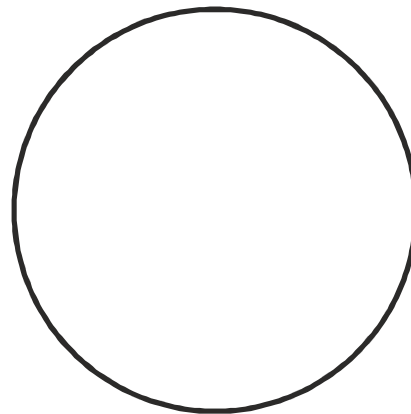
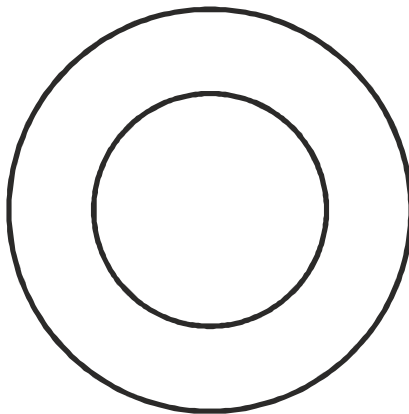
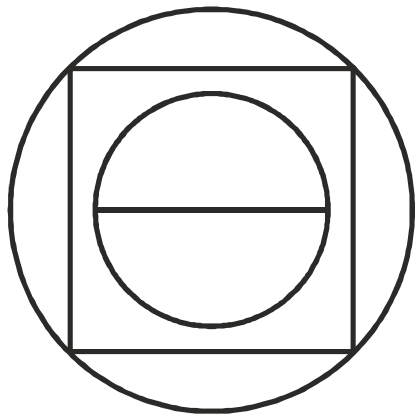
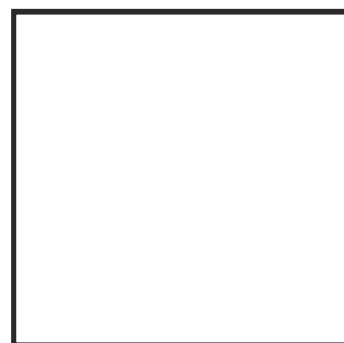
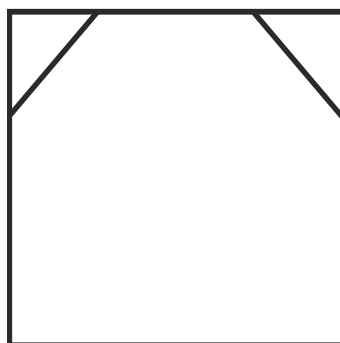
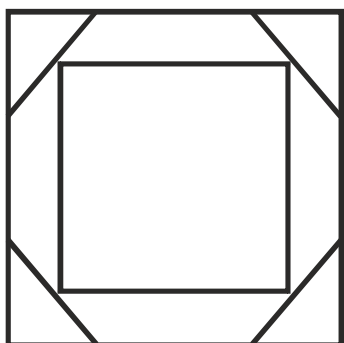
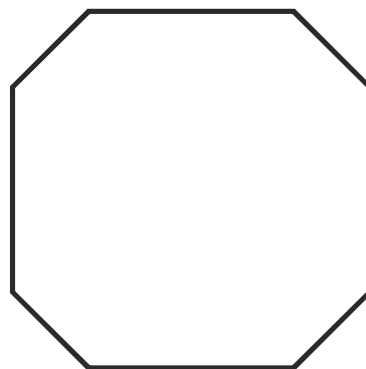
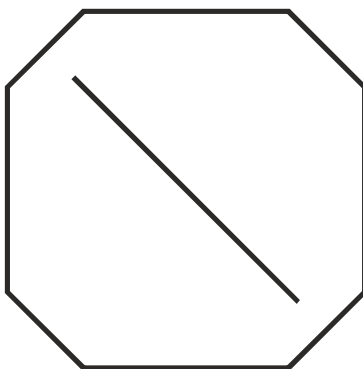
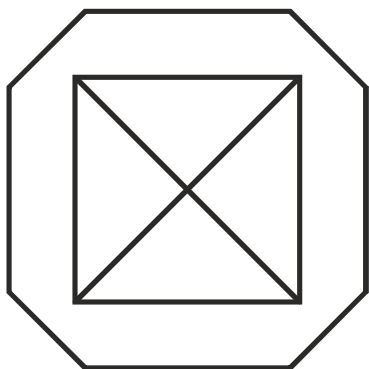

Дорисуй вторую и третью фигуры точно так же, как первую

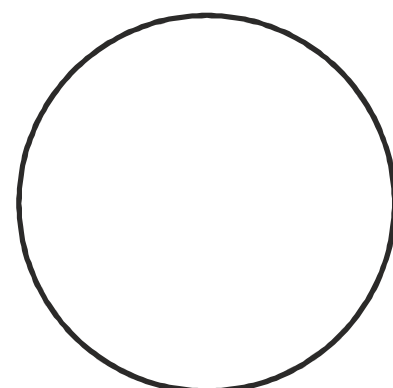
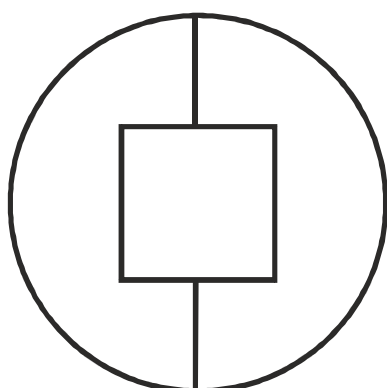
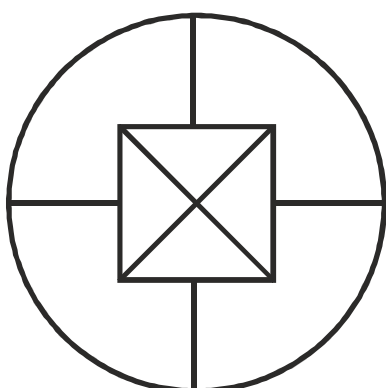
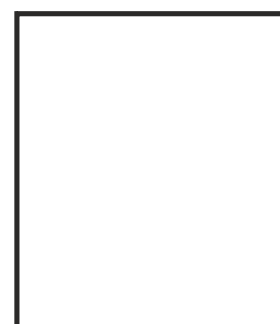
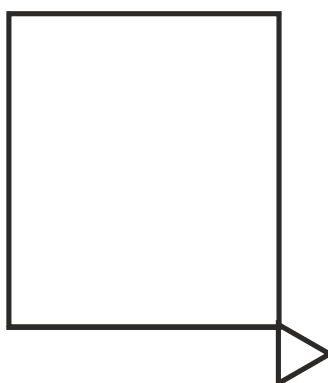
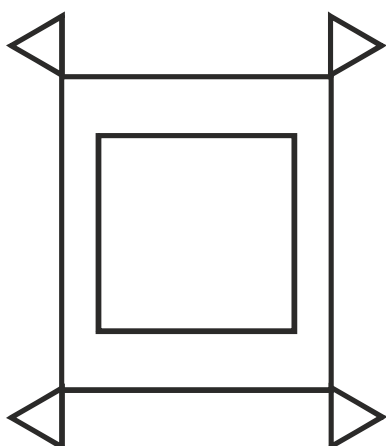
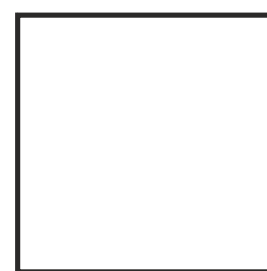
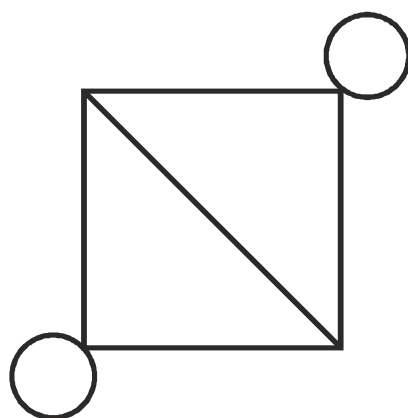
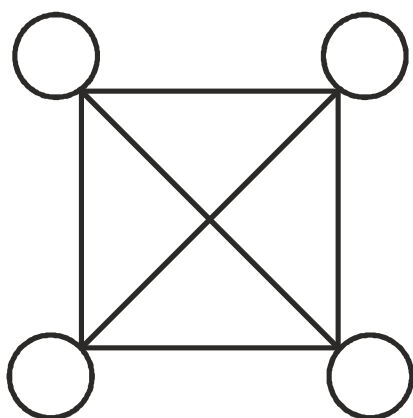
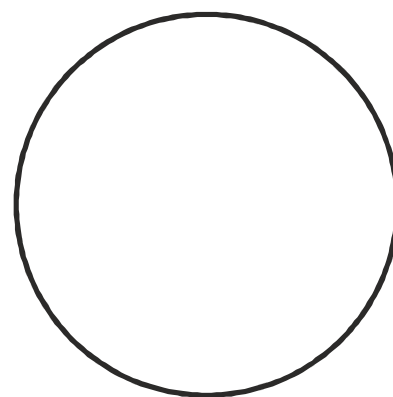
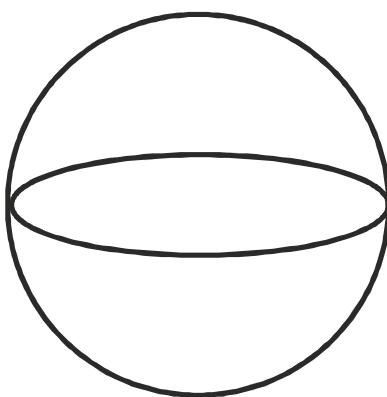
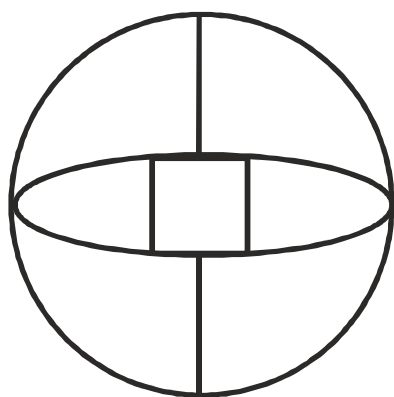

Дорисуй вторые половинки фигур

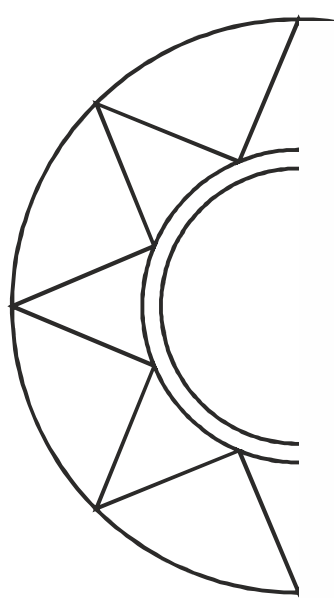
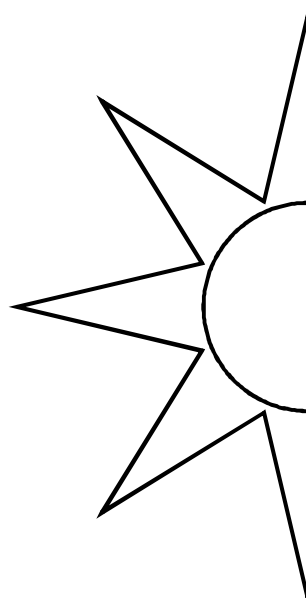
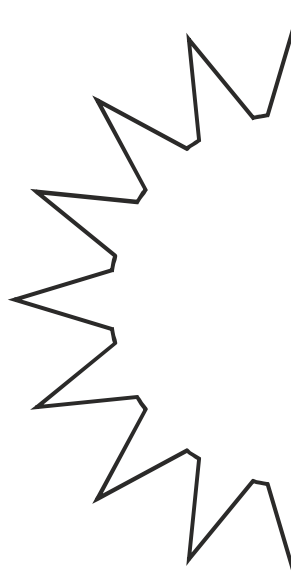
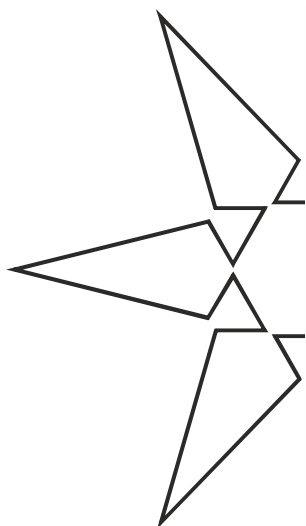
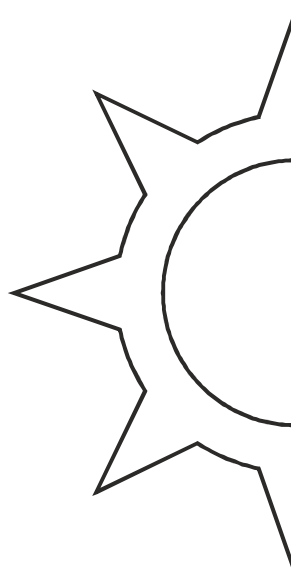

Дорисуй вторые половинки предметов

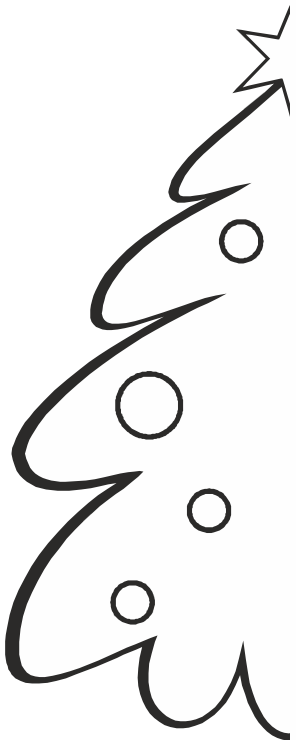
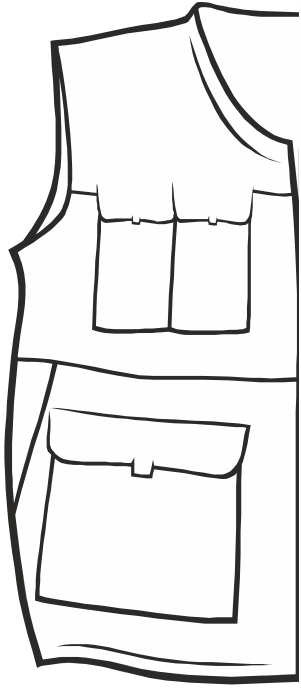

Продолжи рисовать

